

# BURR KING®



**M85**  
85103 shown

**M45**  
45100 shown

**M25**  
25100 shown

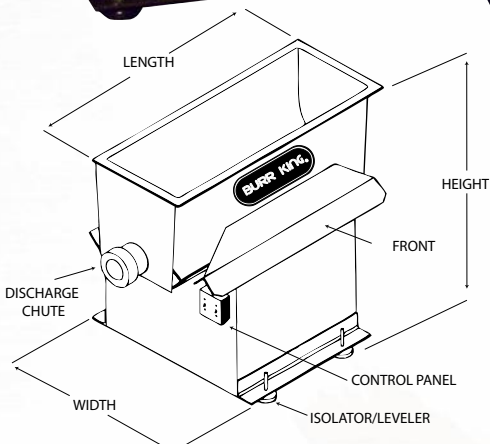

All Burr King tubs or bowls can be used wet or dry.



## Vibra KING® with Hush Design

### GENERAL DATA

	M25	M45	M85
Length max.in.	29	43	48
Width max in.	33	33	36
Height max in.	41	41	45
Total volume cu. ft.	2.5	4.5	8.5
Working volume cu.ft.	2.1	3.8	7.2
Tub depth, inside	15	15	20
Tub length, inside	20	35	37
Tub Width, inside	16	16	20
Max. part length, in.	19	34	36
Media load, lbs	150	250	450
Part load, lbs*	100	225	450
Weight max. lbs. (empty)	390	475	675
Horse power, standard	0.75 (1PH/3PH)	1.5 (1PH/3PH)	3.0 (3PH)

ALWAYS WEAR PROTECTIVE EYE, FACE, ARM, LEG AND BODY GEAR WHEN USING ANY GRINDER, POLISHER, BUFFER OR OTHER ROTATING MACHINERY.